

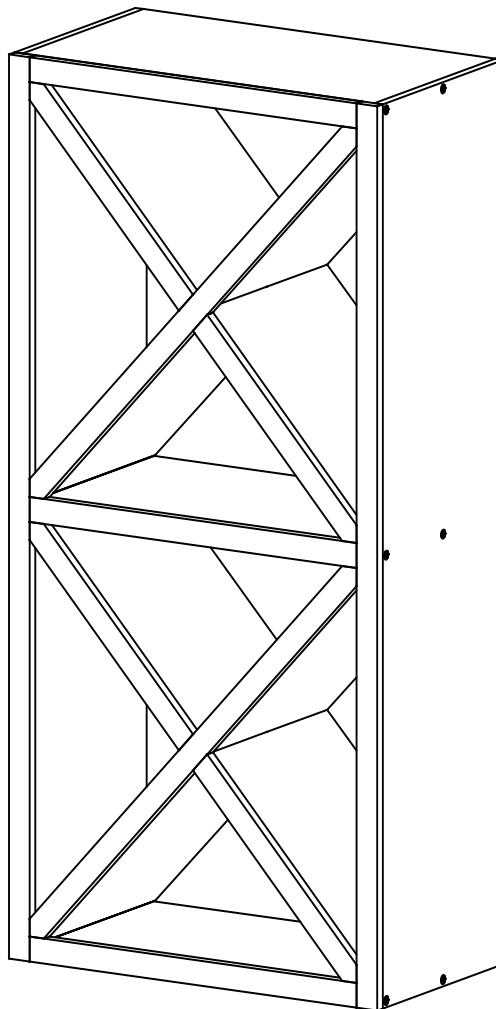

WINEENTHUSIAST®

ASSEMBLY INSTRUCTIONS



N'FINITY STACKABLE SOLID DIAMOND CUBE





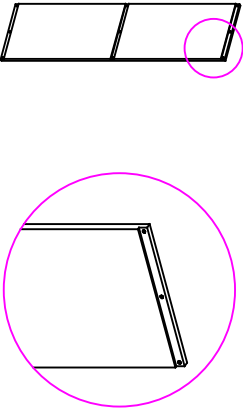
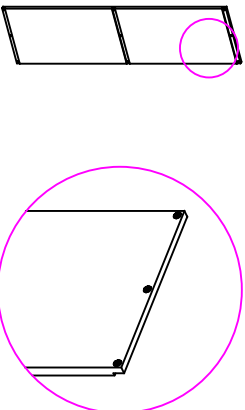
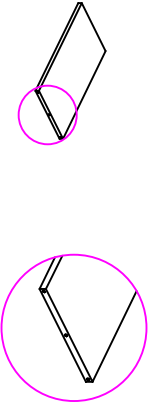
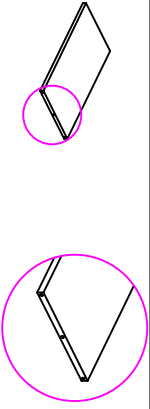
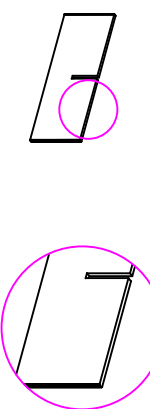

WineEnthusiast.com
800.356.8466

N'FINITY STACKABLE SOLID DIAMOND CUBE

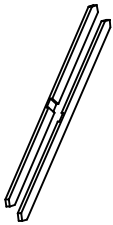
PARTS & HARDWARE

CODE	DESCRIPTION	QTY	SKETCH DRAWING
A1	Left part	1 pcs	
A2	Right part	1 pcs	
B	Top And Bottom part	2 pcs	
C	Center part	1 pcs	
D	Center cross bar	4 pcs	
E	KD Bolt	18 pcs	

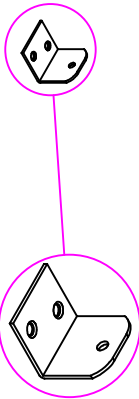
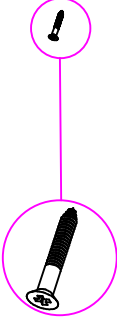
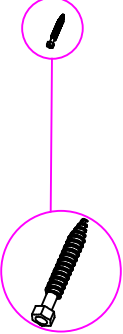
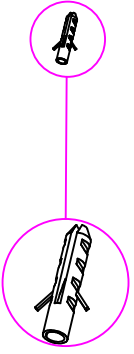
CODE	DESCRIPTION	QTY	SKETCH DRAWING
F	Center cross front trim	4 pcs	
G	Straight front trim	5 pcs	

Hardware (addition / optional to hang the rack on the wall)			
H	Hanging Plat	2 pcs	
I	3/4" #6 Screw	4 pcs	
J	TV Bolt	2 pcs	
K	Wall Fisher	2 pcs	
L	Ring	2 pcs	

Note:

Hexagonal wrench, hammer and nails are required for assembly. Don't overtighten KD bolts to minimize the risk of wood splitting.

N'FINITY STACKABLE SOLID DIAMOND CUBE

ASSEMBLY INSTRUCTIONS

1

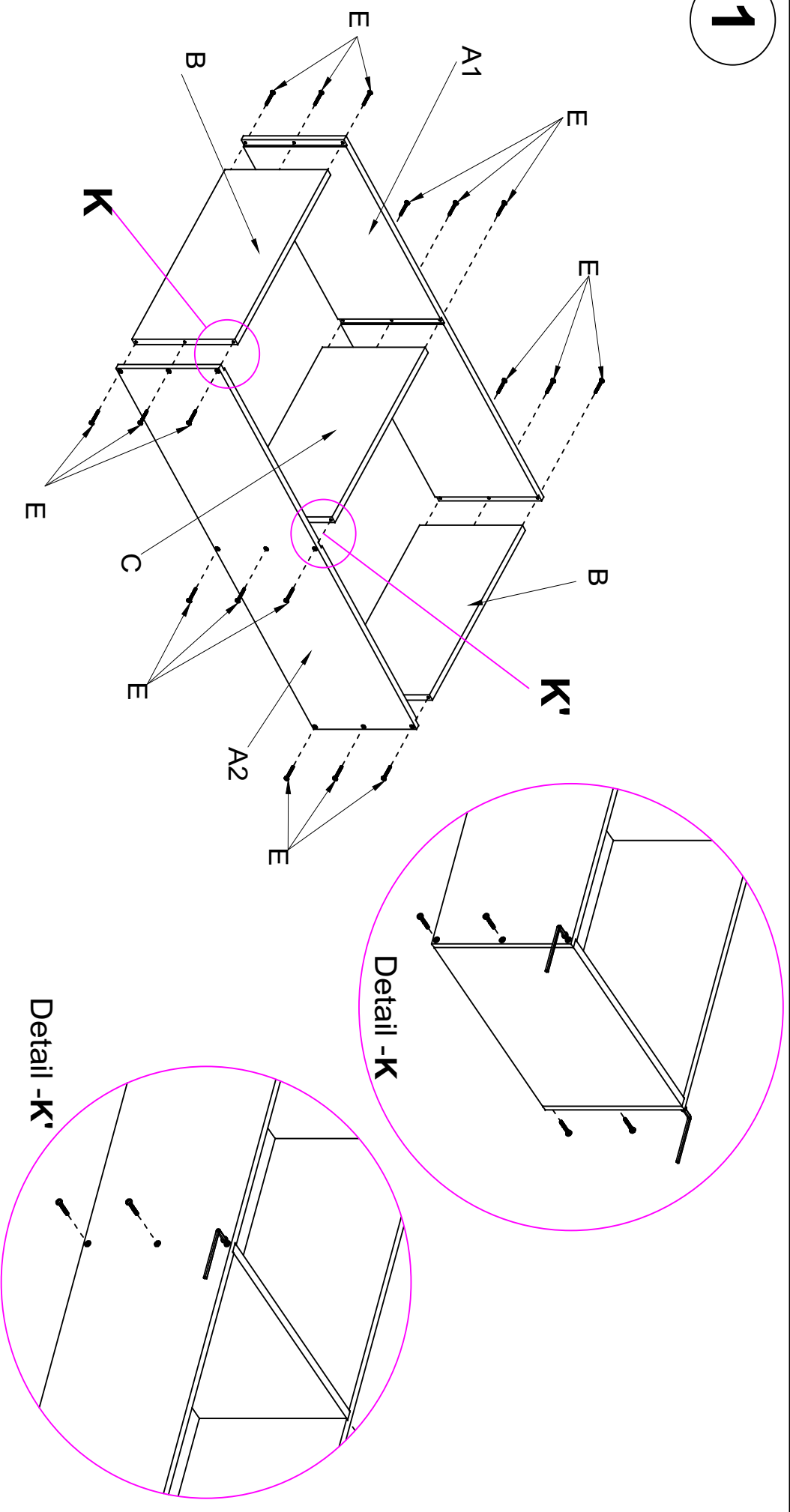

Step 1. It is easiest to assemble lying horizontally. Attach the left part (A1), right part (A2) to top part (B) and bottom part (B) (see picture 1) with 12 pcs KD bolt (E). See detail-K for clarification. Next, install the center part (C) to left part (B) and right part (B) using 6 pcs KD bolt. See detail -K' for clarification. Tighten the KD bolt using hexagonal wrench.

N'FINITY STACKABLE SOLID DIAMOND CUBE ASSEMBLY INSTRUCTIONS

2

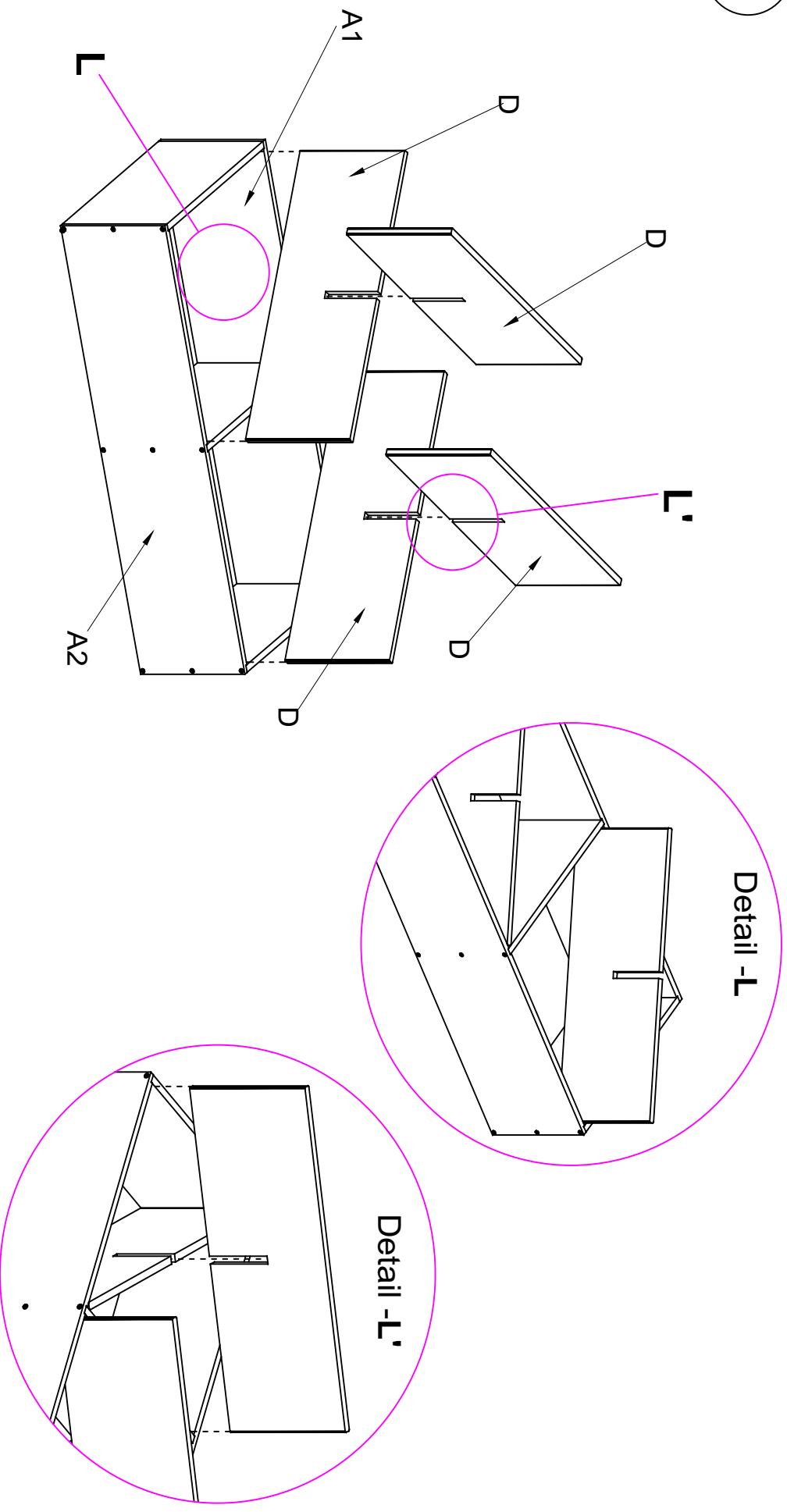

Step 2. Attach the first center cross bars (D) with the groove position facing forward. See detail -L for clarification. Then, install the another center cross bars (D) with the groove position facing backward. See detail -L' for clarification.

N'FINITY STACKABLE SOLID DIAMOND CUBE

ASSEMBLY INSTRUCTIONS

3

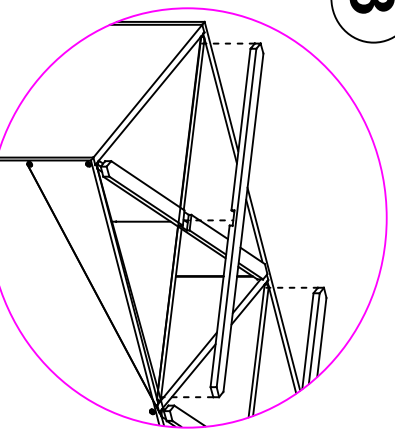

Detail -M

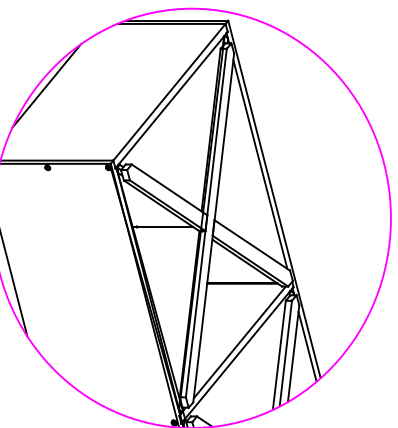

Detail -M'

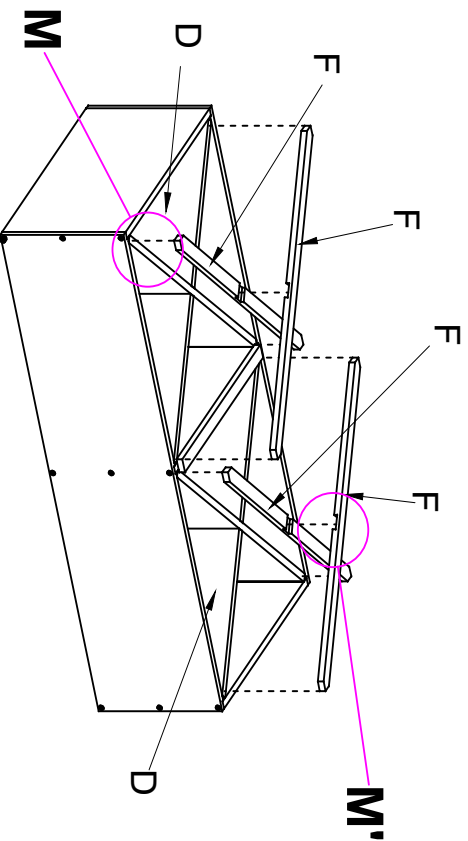

Step 3. Arrange one by one the center cross front trim (F) to the front of the cross shelves. See detail-M and detail-M' for clarification.

4

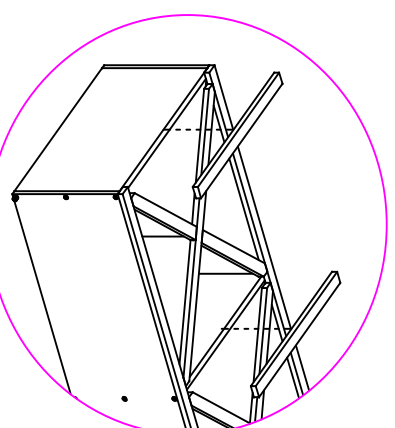

Detail -N

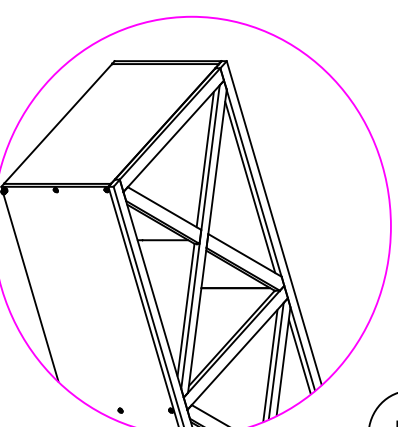

Detail -N'

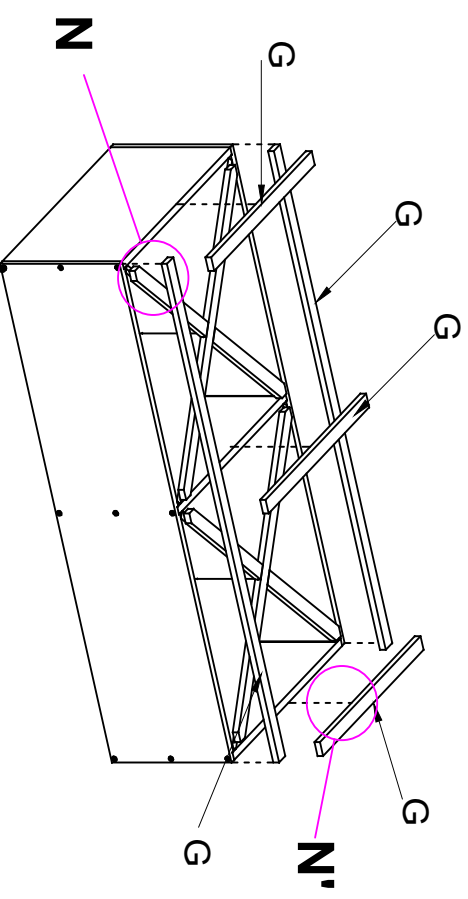

Step 4. Attach the straight front trim (G) to the front of the rack (see detail -N and detail -N' for clarification). Next nail all the trim using nails and a hammer.

INSTRUCTION FOR ATTACHING RACK TO WALL (OPTIONAL)

1

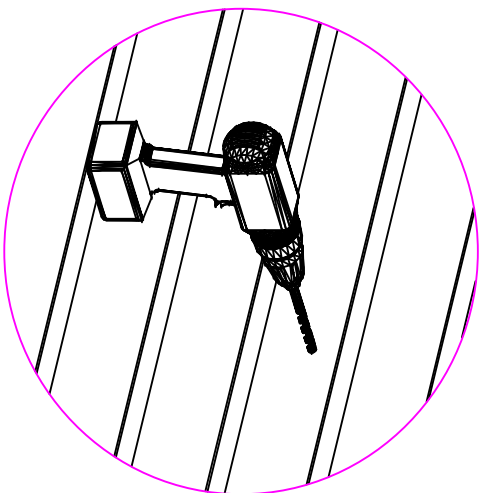
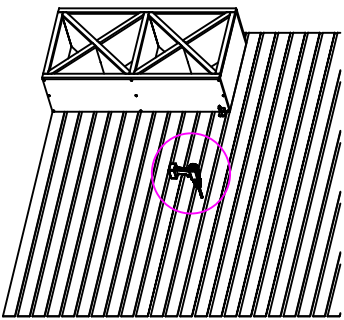

2

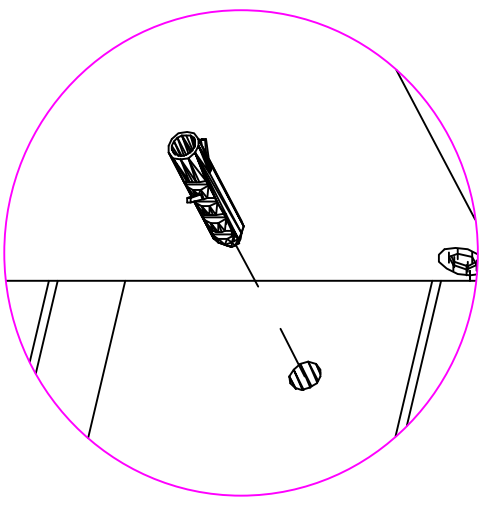
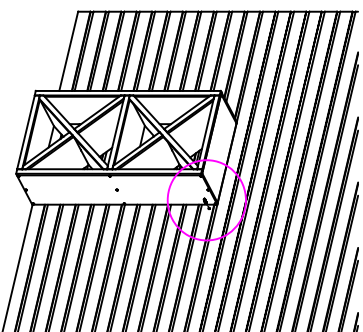

3

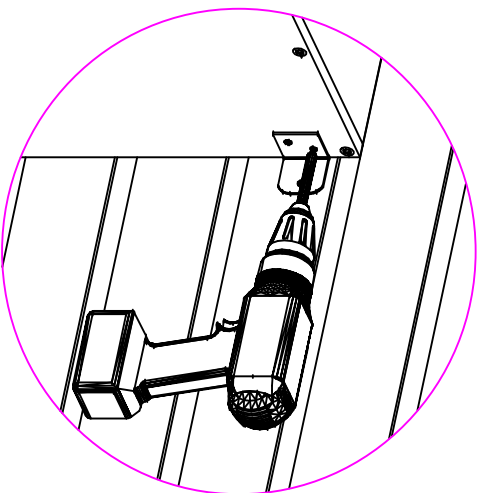
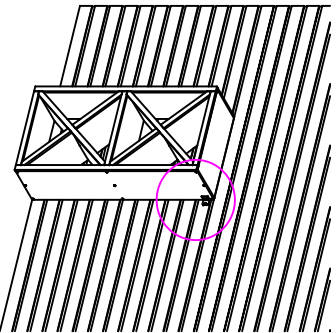

4

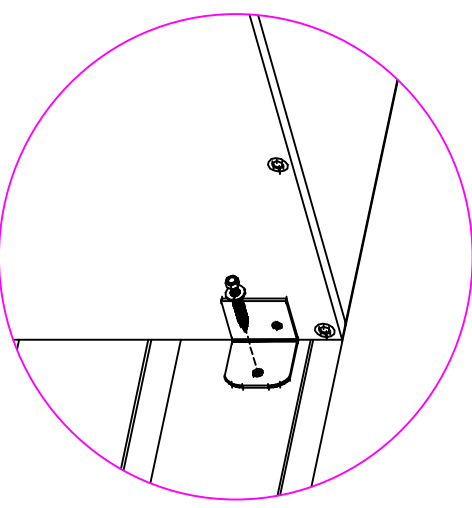
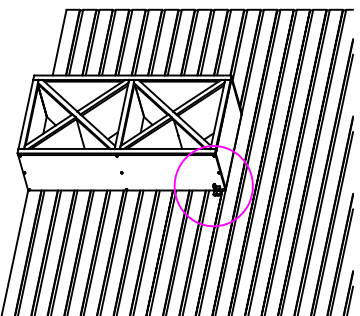

Step :

1. Drill the wall, diameter of drill hole according the diameter of the wall fisher.
2. Put the wall fisher into the drill hole.
3. Attach the hanger plate to the rack using screws.
4. Position the rack and plate into the drilled hole on the wall, then secure it using the tv bolt.

N'FINITY STACKABLE SOLID DIAMOND CUBE

COMPLETED ASSEMBLY SHOWN

