

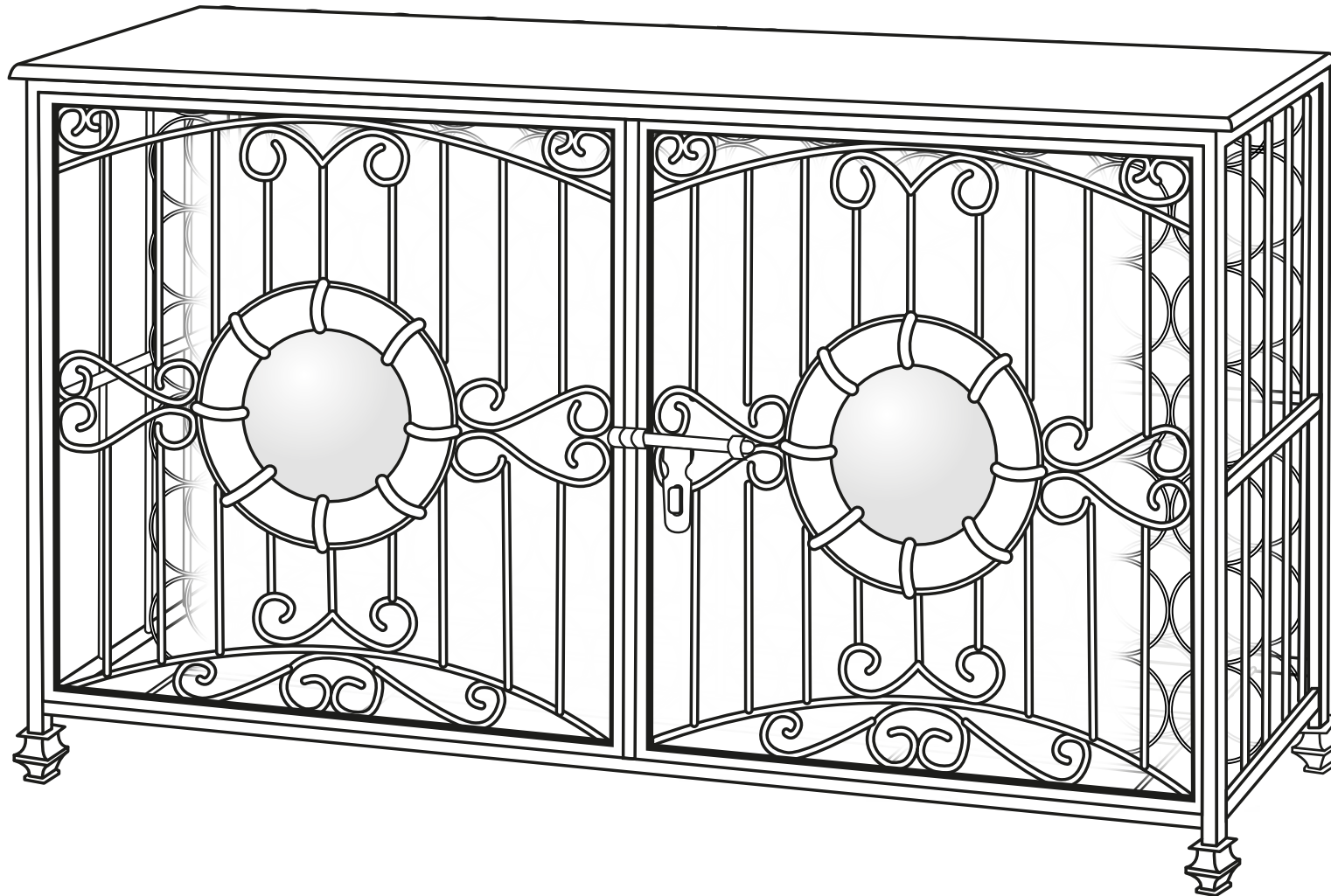





Wine Enthusiast Companies, 333 North Bedford Road, Mount Kisco, NY 10549

## ASSEMBLY INSTRUCTIONS



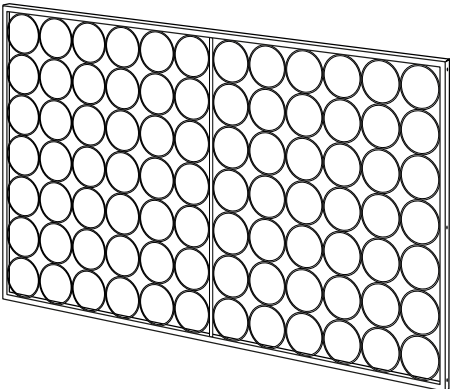
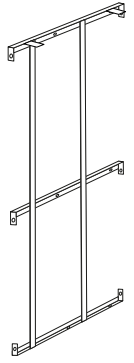
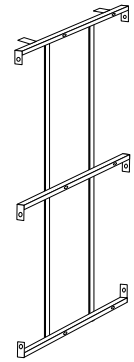
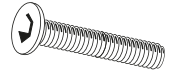
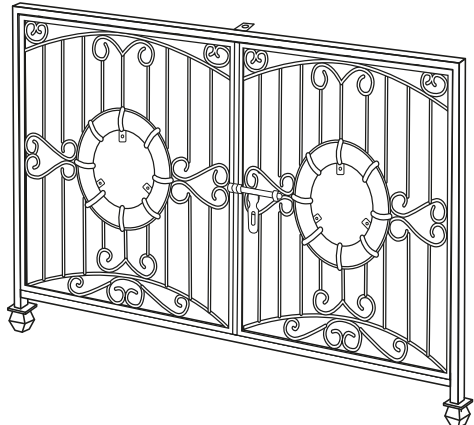
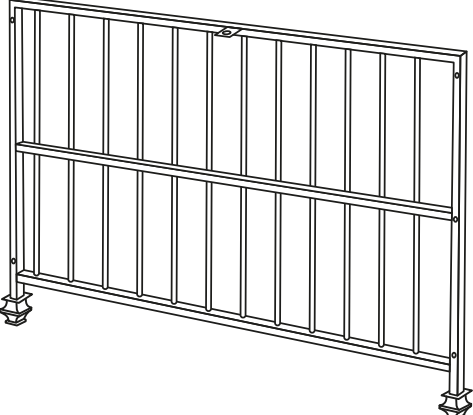

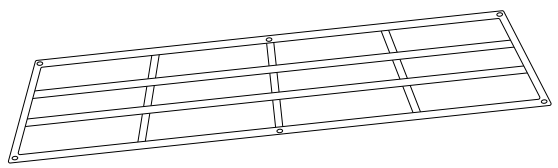
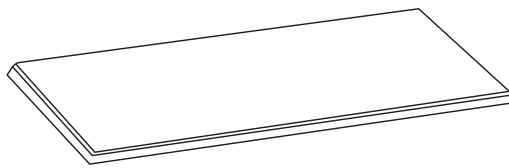
Wine Enthusiast Companies, 333 North Bedford Road, Mount Kisco, NY 10549

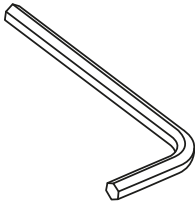
 <p><b>A</b> 2 PCS</p>	 <p><b>B</b> 1 PC</p>	 <p><b>C</b> 1 PC</p>	 <p><b>D</b> 12 PCS</p>
 <p><b>E</b> 1 PC</p>	 <p><b>F</b> 1 PC</p>	 <p><b>G</b> 24 PCS</p>	 <p><b>H</b> 2 PCS</p>
 <p><b>J</b> 1 PC</p>	 <p><b>K</b> 1 PC</p>	 <p><b>I</b> 6 PCS</p>	 <p><b>L</b> 2 PCS</p>

Please review contents and ensure all pieces are included in your box.  
For the best results, it is recommended that two people assemble this product.



Wine Enthusiast Companies, 333 North Bedford Road, Mount Kisco, NY 10549

## ASSEMBLY INSTRUCTIONS

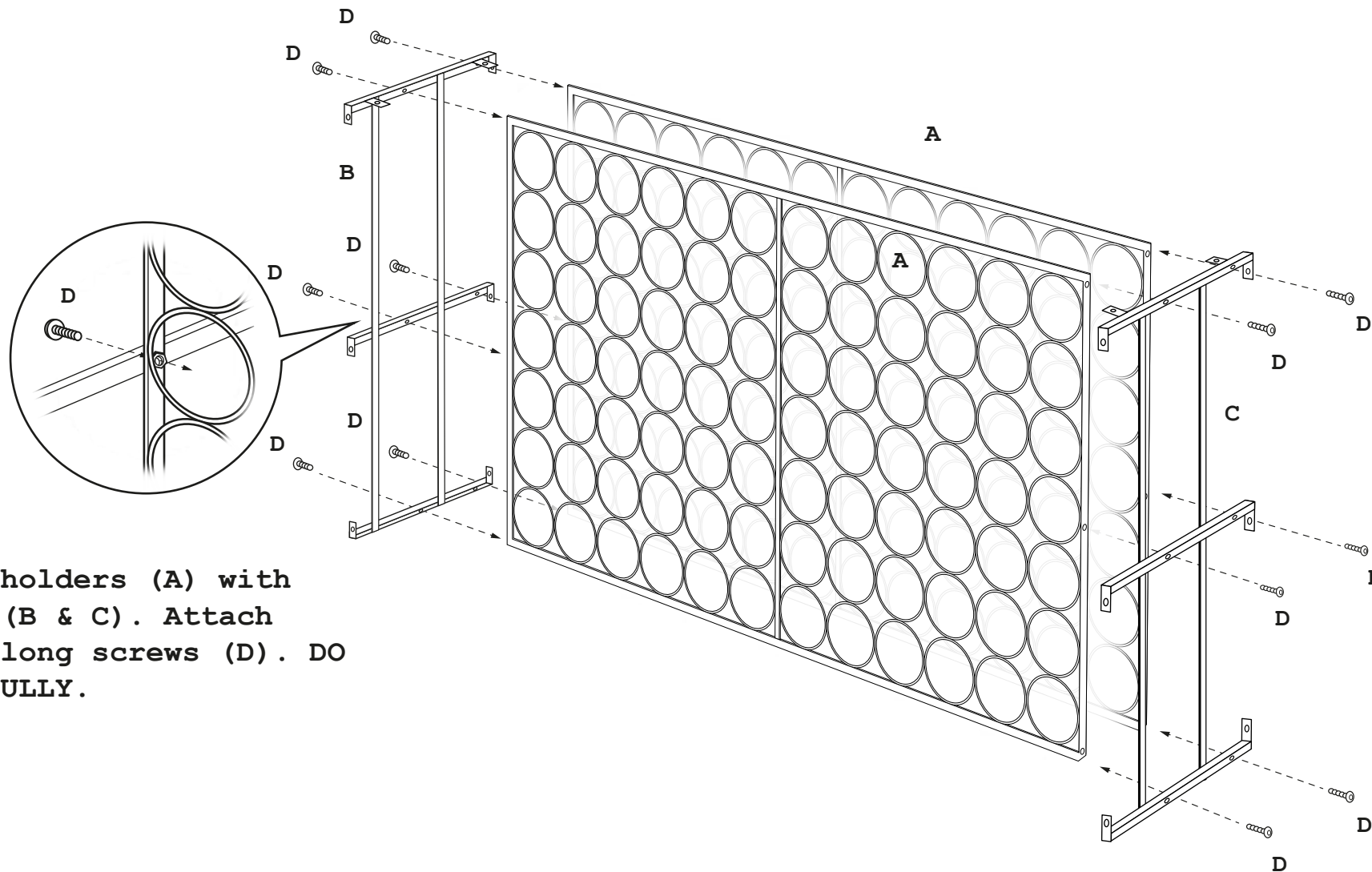

### Step 1

Line up wine holders (A) with outer frames (B & C). Attach loosely with long screws (D). DO NOT TIGHTEN FULLY.

\*Note, it is important not to tighten screws when first assembling so as to maintain alignment of all pre-drilled holes. It is very important to go back and tighten all screws once the unit is fully together, before filling with wine.



# WINEENTHUSIAST

www.wineenthusiast.com

Wine Enthusiast Companies, 333 North Bedford Road, Mount Kisco, NY 10549

## ASSEMBLY INSTRUCTIONS

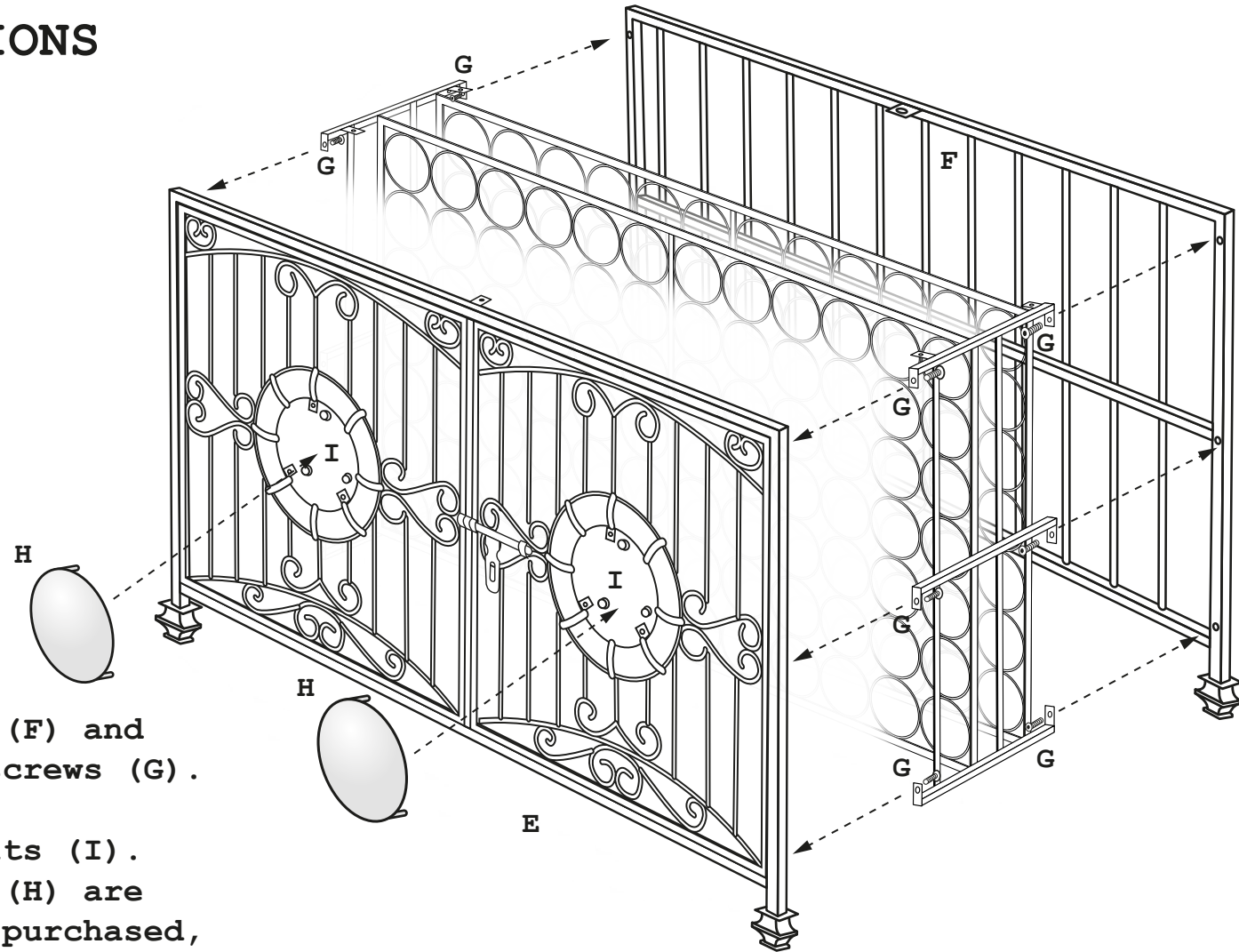

### Step 2

Line up front (E) and back (F) and attach loosely with short screws (G). DO NOT TIGHTEN FULLY.

Attach plaques (H) with bolts (I). Please note, blank plaques (H) are included; if initials were purchased, please replace the blanks with your chosen letters.

\*Note, it is important not to tighten screws when first assembling so as to maintain alignment of all pre-drilled holes. It is very important to go back and tighten all screws once the unit is fully together, before filling with wine.



Wine Enthusiast Companies, 333 North Bedford Road, Mount Kisco, NY 10549

## ASSEMBLY INSTRUCTIONS

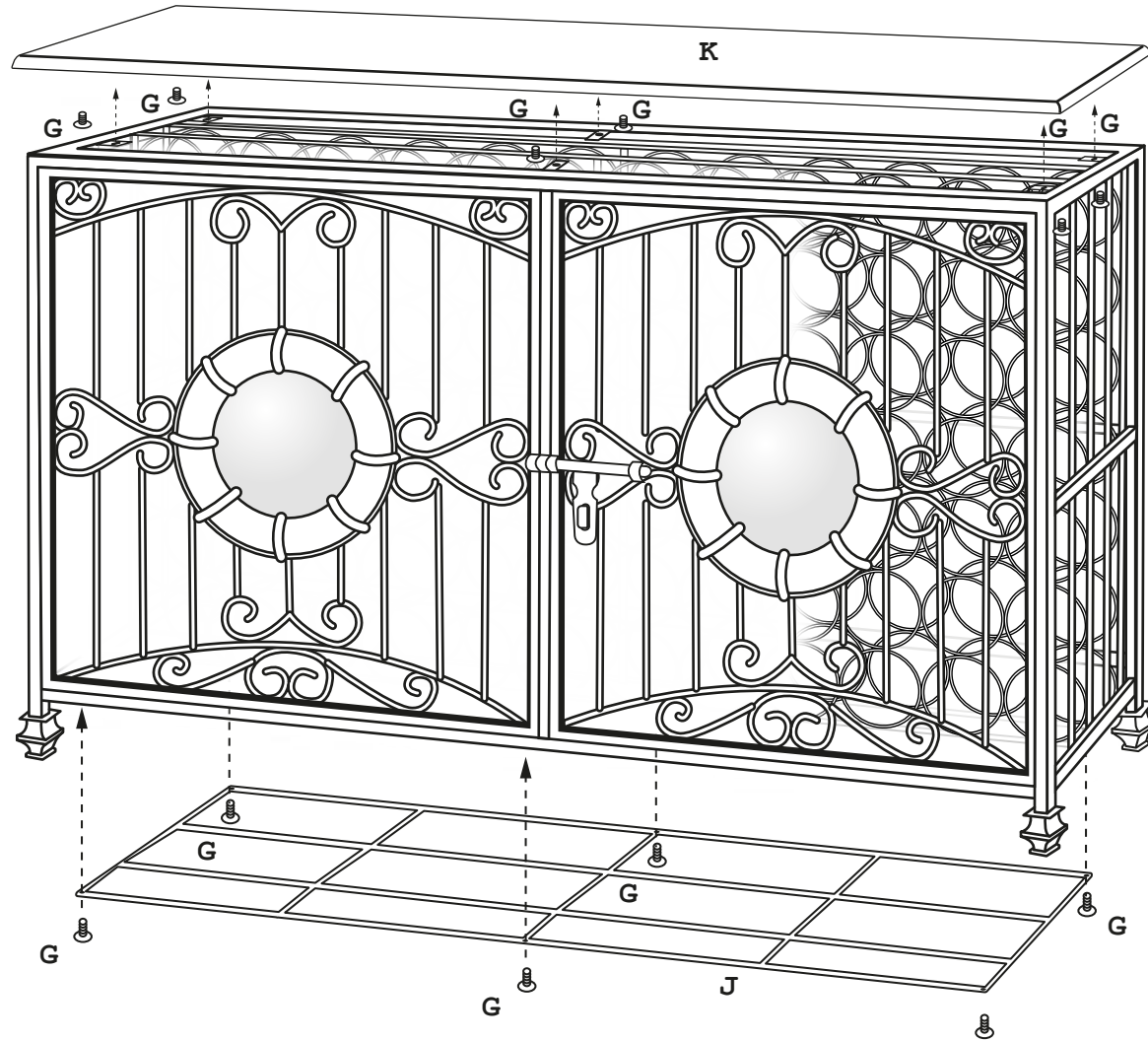

### Step 3

Place wood top (K) on top of assembled piece. Use short screws (G) to attach. Carefully turn unit upside down. Place bottom of frame (J) and use short screws (G) to attach.

**Go back and tighten all screws!**

\*Note, it is important not to tighten screws when first assembling so as to maintain alignment of all pre-drilled holes. It is very important to go back and tighten all screws once the unit is fully together, before filling with wine.